



Acrylic Spa Owner's Manual



Customer Service 1•800•787•6649

email: support@strong9.com

READ AND FOLLOW ALL INSTRUCTIONS



Unit is IPX5 Compliant

*Congratulations on your purchase of a spa
manufactured by Strong Spas™.*

Your new spa will bring you years of
enjoyment and relaxation.

Please take the time to familiarize yourself with the safety precautions,
and operational procedures,
as well as the routine water maintenance and cleaning
so that your spa will provide a
healthy environment for all your bathers.

Enjoy!

Important Safety Instructions and Warnings	4
Prepare for Your New Spa	
Plan the Best Location	6
Prepare a Good Foundation	6
Electrical Installation (240 V 60HZ North America).....	7
Identifying the Spa’s Electrical Components	8
GFCI Wiring Diagram (240 V 60HZ North America).....	9
GFCI Wiring Diagram (230 V 50HZ Europe)	10
Operating Your Spa	
Filling and Starting Up Your Spa	12
Priming the Pump	13
Topside Control Panels	14
Operational and Energy Tips	17
Mode	18
Control Pack Codes	19
Personalized Settings	
Jets, Air Controls, Diverters, Remotes, Waterfalls	24
LED Lighting	25
Testing and Adjusting Spa Water	
Water Maintenance Overview	26
Sanitation, Ozonator, Filtration, Chemical Balance, Testing Methods	26
Balancing Your Spa’s Water Chemistry (Alkalinity, Calcium Hardness, pH)	27
Chlorine and Bromine Sanitation Overviews	27
Chemical Safety	28
Filter Cleaning	29
Starting the Spa with Fresh Water.....	29
Maintenance Schedule	30
Troubleshooting	
Water Quality Problems	31
Operational Problems	32
Cleaning and Care	
Draining Your Spa	35
Vacation Care	35
Cleaning Your Spa	36
Removing and Reseating the Pillows	36
Spa Cover	36
Jet Removal and Replacement	37
Sound System.....	37
Winterizing.....	38
Product Registration	43

CONTACT INFORMATION

For customer service, please call 1-800-787-6649

Strong™ Spas

3204 Point Township Drive, Northumberland, PA 17857 USA

*Strong™ Spas reserves the right to make product modifications and enhancements without notice.
Specifications and dimensions are approximate and for reference only.*

READ AND FOLLOW ALL INSTRUCTIONS

To reduce the risk of injury, do not permit children to use this product unless they are closely supervised at all times.



Warning: Children should not use spas or hot tubs without adult supervision.

Avertissement: Ne pas laisser les enfants utiliser une cuve de relaxation sans surveillance.



Warning: Do not use spas or hot tubs unless all suction guards are installed to prevent body and hair entrapment.

Avertissement: Pour éviter que les cheveux ou une partie du corps puissent être aspirés, ne pas utiliser une cuve de relaxation si les grilles de prise d'aspiration ne sont pas poutes en place.



Warning: People using medications and/or having an adverse medical history should consult a physician before using spa or hot tub.

Avertissement: Les personnes qui prennent des médicaments ou ont des problèmes de santé devraient consulter un médecin avant d'utiliser une cuve de relaxation.



Warning: People with infectious diseases should not use a spa or hot tub.

Avertissement: les personnes atteintes de maladies infectieuses ne devraient pas utiliser une cuve de relaxation.



Warning: To avoid injury, exercise care when entering or exiting the spa or hot tub.

Avertissement: Pour éviter des blessures, user de prudence en entrant dans une cuve de relaxation en sortant.



Warning: Do not use drugs or alcohol before or during the use of a spa or hot tub, to avoid unconsciousness and possible drowning.

Avertissement: Pour éviter l'évanouissement et la noyade éventuelle, ne prendre ni drogue ni alcool avant d'utiliser une cuve de relaxation ni quand on s'y trouve.



Warning: Pregnant or possibly pregnant women should consult a physician before using a spa or hot tub.

Avertissement: Les femmes enceintes, que leur grossesse soit confirmée ou non, devraient consulter un médecin avant d'utiliser une.



Warning: Water temperature in excess of 38°C may be injurious to your health.

Avertissement: Il peut être dangereux pour la santé de se plonger dans de l'eau à plus de 38°C.



Warning: Before entering the spa or hot tub, measure the water temperature with an accurate thermometer.

Avertissement: Avant d'utiliser une cuve de relaxation mesurer la température de l'eau à l'aide d'un thermomètre précis.



Warning: Do not use a spa or hot tub immediately following strenuous exercise.

Avertissement: Ne pas utiliser une cuve de relaxation immédiatement après un exercice fatigant.

SAVE THESE INSTRUCTIONS

READ AND FOLLOW ALL INSTRUCTIONS

To reduce the risk of injury, do not permit children to use this product unless they are closely supervised at all times.



Warning: Prolonged immersion in a spa or hot tub may be injurious to your health.

Avertissement: L'utilisation prolongée d'une cuve de relaxation peut être dangereuse pour la santé.



Warning: Do not permit or use electric appliances (such as a light, telephone, radio or television) within 1.5 meters of spa or hot tub.

Avertissement: Ne pas placer d'appareil électrique (luminaire, téléphone, radio, téléviseur, etc.) à moins de 1.5 meters de cette cuve de relaxation.



Caution: Maintain water chemistry in accordance with the manufacturer's instructions.

Attention: La teneur de l'eau en matières dissoutes doit être conforme aux directives du fabricant.



HYPERTHERMIA

Hyperthermia occurs when the internal temperature of the body reaches a level several degrees above the normal body temperature of 37°C. The symptoms of hyperthermia include:

- 1) Unawareness of impending hazard;
- 2) Failure to perceive heat;
- 3) Failure to recognize the need to exit the spa or hot tub;
- 4) Physical inability to exit the spa or hot tub;
- 5) Fetal damage in pregnant women; and
- 6) Unconsciousness and resulting in the danger of drowning.



Warning: The use of alcohol or drugs can greatly increase the risk of fatal hyperthermia in hot tubs or spas.

Avertissement: La consommation d'alcool ou de drogue augmente considérablement.

SAVE THESE INSTRUCTIONS

Prepare for Your New Spa

Prepare for Your New Spa

Most cities and counties require permits for exterior construction and electrical circuits. In addition, some communities have codes requiring residential barriers such as fencing and/or self-closing gates on property to prevent unsupervised access to the property by children. Your local code enforcement officer can provide information on which permits may be required and how to obtain them prior to the delivery of your spa.

Prepare a Good Foundation

Damage caused by an inadequate or improper foundation is not covered by the warranty. The spa owner is responsible for providing a proper foundation. Place the spa on a solid, level foundation. If you are installing the spa indoors (not recommended), pay close attention to the flooring beneath it. Choose flooring that will not be damaged or stained. If you are installing your spa on an elevated wood deck or other structure, consult a structural engineer or a contractor to ensure the structure will support the weight of 150 pounds per square foot.

Plan the Best Location



SAFETY FIRST

Do not place your spa within 10 feet (3 m) of overhead power lines.

Do not use in warm, damp, equable climates.

IMPORTANT: Strong™ Spas Warranty is void if the spa is moved to any location that is not the original 'Ship To' address.

Consider Spa Use

How you intend to use your spa will help you determine where you should position it. For example, will you use your spa for recreational or therapeutic purposes? If your spa is mainly used for family recreation, be sure to leave plenty of room around it for activity. If you will use it for relaxation and therapy, you will probably want to create a specific mood around it.

Climate, Privacy and View

Place the spa near a house entry if you live in a snowy or rainy environment so you have a place to comfortably change clothes. Consider seasonal changes, too. Bare trees don't provide much privacy. And don't forget to think of your neighbors' view of you, and your view of your neighbors.

Keep Your Spa Clean

In planning your spa's location, consider a location where there is a clean path to and from the house. Use a mat at the spa's entrance to encourage bathers to clean their feet before entering your spa.

Allow for Service Access

If you are installing your spa near a wall or with any type of structure on the outside, such as a gazebo, remember to allow access for service.



240 Volt Electrical Installation

(North America 60hZ)



WARNING:

The electrical circuit must be installed by an electrical contractor and approved by a local building or electrical inspector.

Failure to comply with state and local codes may result in fire or personal injury and will be the sole responsibility of the spa owner.

Improper installations present hazards which can result in personal injury or property damage and void the warranty on the spa.

Spa jumpers and dip switches are preconfigured for a 240V installation.

- All 240V spas must be permanently hardwired to the power supply. See US wiring diagram on page 9, European wiring diagram on page 10.
- Spas must be wired using this procedure. Any variance from these instructions will void your warranty and may result in serious injury.

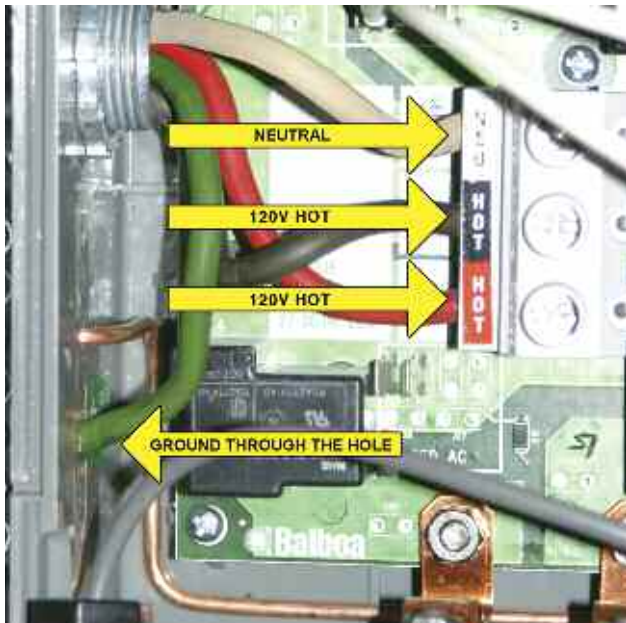

- When installed in the United States, the electrical wiring of this spa must meet the requirements of National Electric Code, ANSI/NFPA 70-2008 and any applicable local, state, and federal codes.

GFCI and Wiring Requirements

- The power supplied to the spa must be on a dedicated GFCI protected circuit as required by ANSI/NFPA 70 with no other appliances or lights sharing the power.
- Use copper wire with THHN insulation. Do not use aluminum wire.
- Use the table on the next page to determine your GFCI and wiring requirements.
- When NEC requires the use of wires larger than #6 AWG, install a junction box near the spa and use #6 AWG wire between the junction box and the spa.
- Wire runs over 85 feet must increase wire gauge to the next lower number.

Testing the GFCI Breaker

Test the GFCI breaker prior to first use and periodically when the spa is powered. To test the GFCI breaker follow these instructions

1. With spa operating, press the TEST button on the GFCI. The GFCI will trip and the spa will shut off.
2. Reset the GFCI breaker by switching the breaker to the full OFF position, wait a moment, then turn the breaker back on. The spa should have power again.

Point of Entry for Electric Service

Installations can vary greatly from spa to spa, therefore Strong does not have any pre-determined entry points for electrical service. The installer will need to determine the best point of entry, and create an entry point. Any of the 4 walls or the spa base can be drilled through to make this access point. Prior to drilling, be sure that there are no components on the interior of the cabinet that will possibly be damaged or in the way while making the hole. Strong recommends that some form of moisture barrier is used at the hole to prevent water from entering the spa. As long as all the above criteria are met, this will in no way void the warranty that is included with the spa.

Identifying the Spa's Electrical Components

Locate Electrical Pack Part Number and Model Number

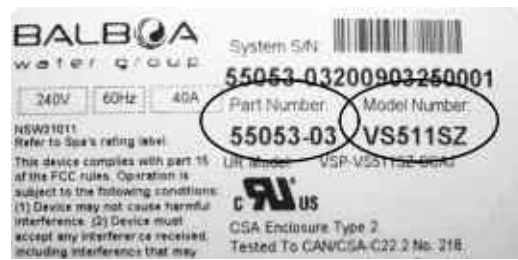

Locate Dip Switch Panel



Balboa Pack Model No. and Part No.	Usage Description and Settings	GFCI Required	Wire(s) Required
Model No. VS501Z Part No. 54379-03	1 pump spa (Pump on hi + heat)	240V 50 AMP	#6 AWG Copper
Model No. VS501Z Part No. 54379-03	1 pump spa + blower or 2 pump (one 2-speed & one 1-speed) (Pump on hi + heat)	240V 50 AMP	#6 AWG Copper
Model No. STRELST 15B Part No. 56256	2 pump spa + blower (1 pump on hi + heater) Dip switch #2 is ON, #3 is OFF. Dip switches #2 and 3 control Amp usage.	240V 50 AMP	#6 AWG Copper
Model No. STRELST 15B Part No. 56256	2 pump spa + blower (2 pumps on hi + heater) Dip switches #2 is OFF, #3 is ON. Dip switches #2 and 3 control Amp usage.	240V 50 AMP	#6 AWG Copper
Model No. STRELST 15B Part No. 56256	3 pump spa + blower (3 pumps on hi + heater) Dip switches #2, 3 are ON. Dip switches #2 and 3 control Amp usage.	240V 60 AMP	#6 AWG Copper
Model No. GS500 Part No. 54520 (L1, N1)	1 pump European Spa Dip switches #2, 3, 6, 7, 8, 10 are ON	230V 20 AMP	#6 AWG Copper
Model No. GS500 Part No. 54520 (L1, N1, L2, N2)	1 pump European Spa Dip switches #2, 3, 6, 7, 8 are ON	230V 40 AMP	#6 AWG Copper
Model No. GS511 Part No. 54521-01 (L1, N1)	2 pump European Spa Dip switches #3, 6, 8, 10 are ON	230V 40 AMP	#6 AWG Copper
Model No. GS511 Part No. 54521-01 (L1, N1, L2, N2)	2 pump European Spa Dip switches #3, 6, 8, 10 are ON	230V 40 AMP	#6 AWG Copper
Model No. GS520SZ Part No. 55423-01 (L1, N1)	2 pump European Spa Dip switches 6, 7, 8, 10 are ON	230V 40 AMP	#6 AWG Copper
Model No. GS520SZ Part No. 55423-01 (L1, N1, L2, N2)	2 pump European Spa Dip switches 6, 7, 8, 10 are ON	230V 40 AMP	#6 AWG Copper
Model No. GS520SZ Part No. 55423-01 (L1, L2, L3, N1)	2 pump European Spa Dip switches 6, 7, 8, 10 are ON	230V 40 AMP	#6 AWG Copper

GFCI Wiring Diagram (North America 240V 60hZ)

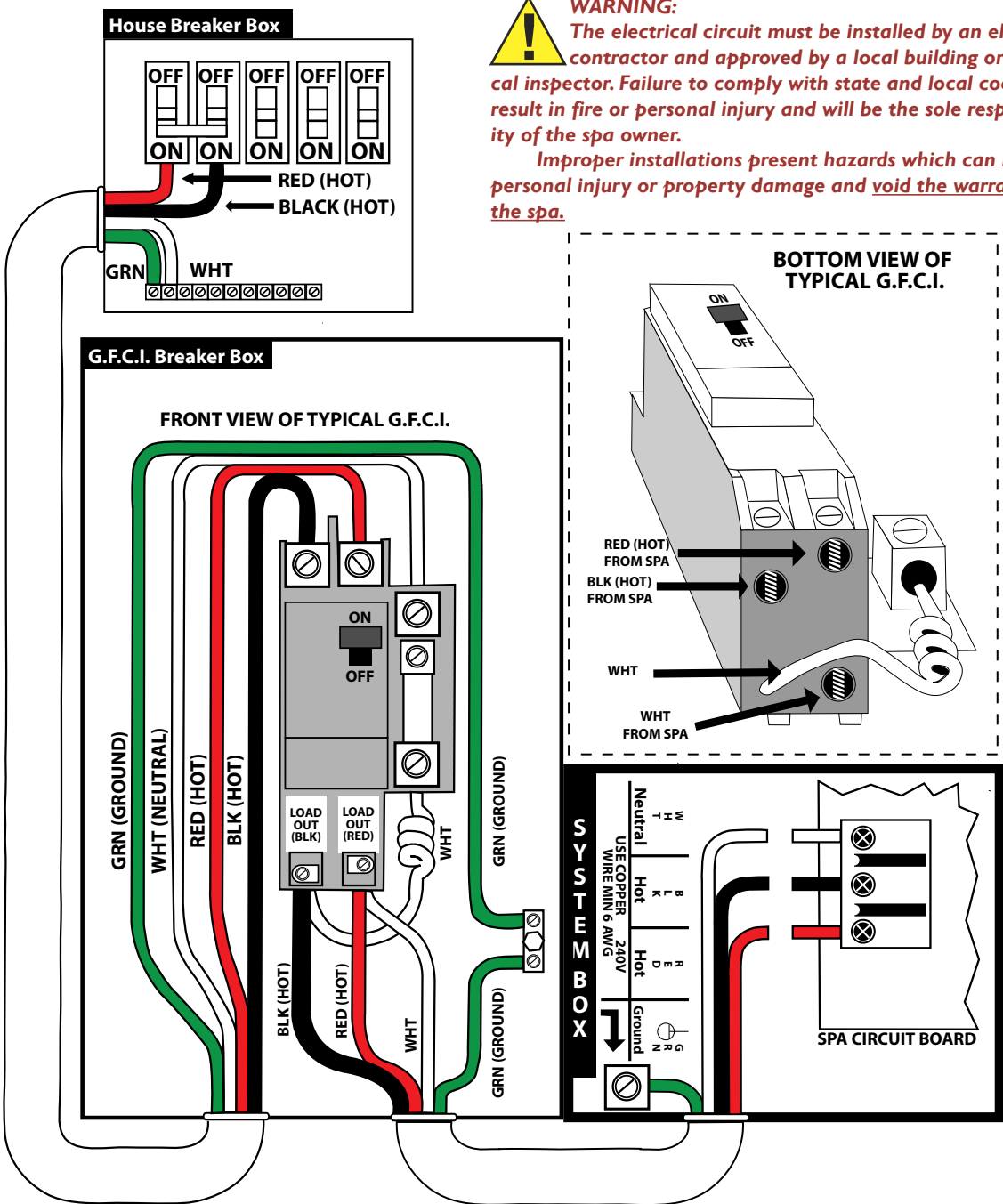

WARNING:
 The electrical circuit must be installed by an electrical contractor and approved by a local building or electrical inspector. Failure to comply with state and local codes may result in fire or personal injury and will be the sole responsibility of the spa owner.

Improper installations present hazards which can result in personal injury or property damage and void the warranty on the spa.

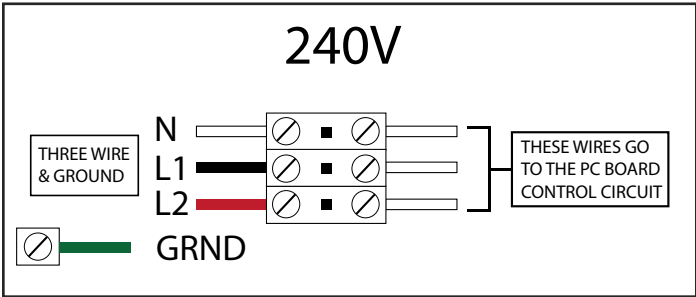

GFCI Wiring Diagram (European 230V 50hZ) Systems with PCB Rev B Only

Note: A residual current device with a tripping current rated not more than 30 mA has to be installed in addition to local requirement.

Protective device for power connection must be on all phase conductors based on local requirements.

AS MANUFACTURED

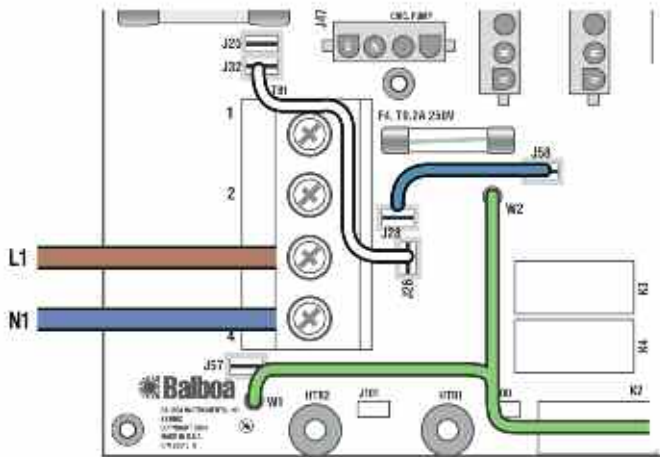

Single Service, TN and TT Electrical Systems

**(1 x 16 Amp or 1 x 32 Amp)
3 Wires (1 Line + 1 Neutral + 1 Protective Earth)**

Protective Earth wire 6mm² minimum (Green/Yellow) must be connected to system ground terminal as marked.

This option is configured and shipped as the default.

All equipment (pumps, blower, and heater) runs on service line L1.

Systems using only 1 DIP switch (A10) for heat disable:

- For 1 x 16 Amp Service:
DIP Switch A10 must be ON.
- For 1 x 32 Amp Service:
Set DIP Switch A10 such that total system amperage draw never exceeds rated service input.

Systems using multiple DIP switches for heat disable:

- Refer to Switchbank settings on inside cover of pack.

Note: A residual current device with a tripping current rated not more than 30 mA has to be installed in addition to local requirement.

Protective device for power connection must be on all phase conductors based on local requirements.

OPTIONAL

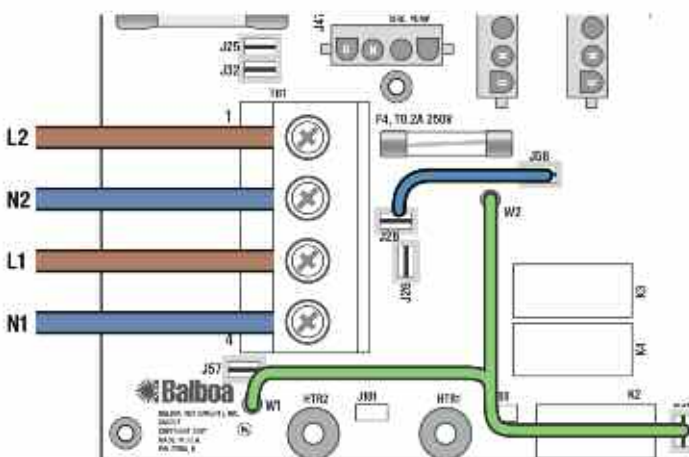

Dual Service, TN and TT Electrical Systems

**(2 x 16 Amp)
5 Wires (2 Lines + 2 Neutrals + 1 Protective Earth)**

Protective Earth wire 6mm² minimum (Green/Yellow) must be connected to system ground terminal as marked.

The heater runs on service line L1, while all other equipment, such as pumps and blowers, run on service line L2.

Completely remove the white wire from J26 and J32.
Note: J32 and J25 are electrically identical. The white wire may be attached to either terminal before removal.

Systems using only 1 DIP switch (A10) for heat disable:

- DIP Switch A10 must be OFF.

Systems using multiple DIP switches for heat disable:

- Refer to Switchbank settings on inside cover of pack.

Prepare for Your New Spa

Note: A residual current device with a tripping current rated not more than 30 mA has to be installed in addition to local requirement.
Protective device for power connection must be on all phase conductors based on local requirements.

3-Phase Service, TN and TT Electrical Systems on 90 jet spa only

5 Wires (3 Lines + 1 Neutral + 1 Protective Earth)

Protective Earth wire 6mm² minimum (Green/Yellow) must be connected to system ground terminal as marked.

IMPORTANT - Service MUST include a neutral wire, with a line to neutral voltage of 230VAC.

The heater runs on service line L1.
All main-board equipment run on service line L3.
Additional equipment, such as expansion boards, run on service line L2.

Completely remove the white wire from J26 and J32, or J25.

Completely remove the blue wire from J28 and J58. If an expansion board is installed, black wire must connect to J28 (Line L2) only.

Systems using only 1 DIP switch (A10) for heat disable:

- DIP Switch A10 must be OFF.

Systems using multiple DIP switches for heat disable:

- Refer to Switchbank settings on inside cover of pack.

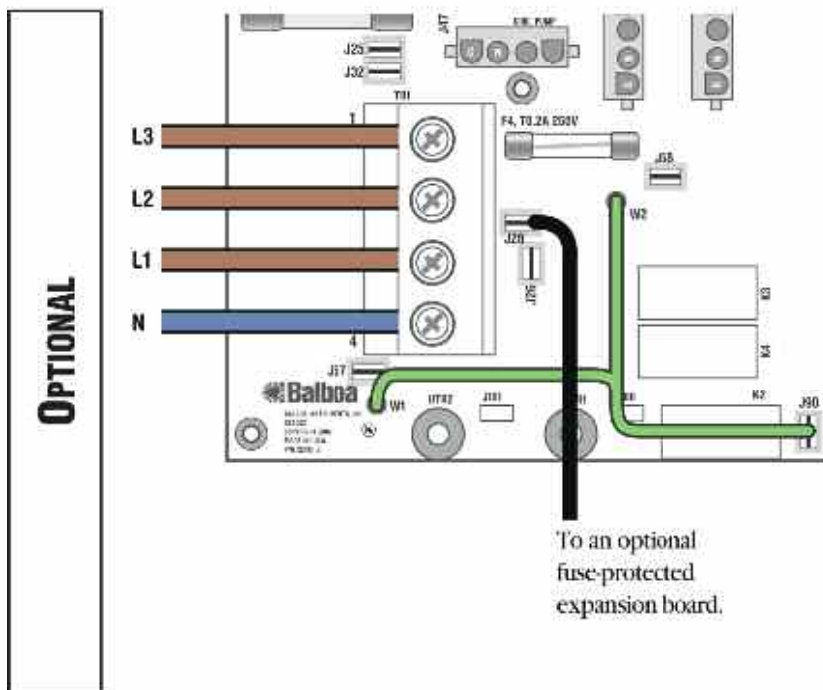

WARNING:
The electrical circuit must be installed by an electrical contractor and approved by a local building or electrical inspector. Failure to comply with state and local codes may result in fire or personal injury and will be the sole responsibility of the spa owner. Improper installations present hazards which can result in personal injury or property damage and void the warranty on the spa.

230 Volt - Single service 1x16 - 20 AMP Breaker
230 Volt - Double service 1x32 - 40 AMP Breaker
Electrical Connections

Two Wire & Earth
(Also known as Ground)

L1
L2
GRND

Earth/Ground = Green & Yellow wire
L1 = Positive/Live = Brown wire
L2 = Negative/Neutral = Blue wire

PLEASE CHECK YOUR LOCAL BUILDING CODES AND ONLY USE A CERTIFIED ELECTRICIAN TO INSTALL ANY ELECTRICAL COMPONENTS TO YOUR SPA.
Substitute these common **HOT, NEUTRAL, EARTH GROUND** colors for your countries standard.

240V/50hZ 29 – 36 Amp draw, depending on model.

Operate Your Spa

Filling and Starting

1. Place spa on an approved surface and have it properly wired by a licensed electrician.
2. Remove exterior spa panels by inserting a flathead screwdriver at bottom edge of panel and prying out.
3. Make sure white plumbing unions are secure and did not loosen during shipping. There will be 4 unions on a 1-pump spa; 6 unions on a 2-pump spa. Hand-tighten any loose unions.

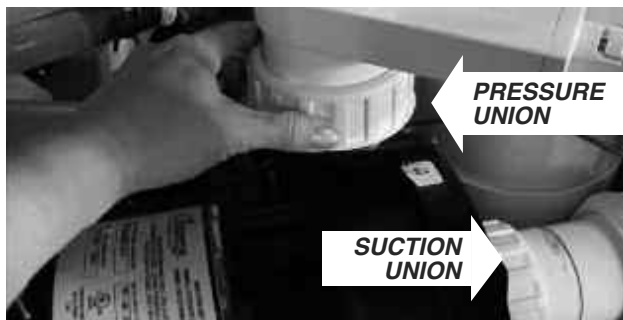

4. Open all gate valves in the equipment area. Before operation, these valves must be in the UP/OPEN position and have plastic clips inserted. Never run the spa with the gate valves closed or without water circulating for any period of time.



5. Remove the filter(s) (and weir and basket, if equipped) from filter chamber. Photos may vary from your particular spa model.



6. Place a garden hose in the filter chamber and fill your spa with regular tap water to 2" higher than the highest jet (excluding neck/shoulder jets).

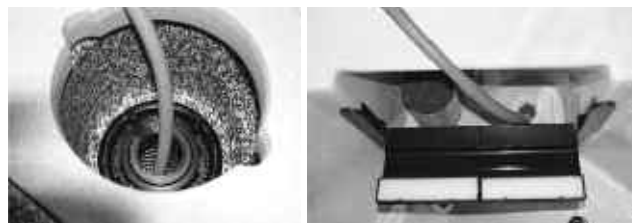

Do not fill your spa with soft water. It is difficult to maintain proper water chemistry with soft water. Also, the water may foam, which will eventually harm the finish of the spa and void your warranty.

7. If you have an automatic bromine generator, turn it off.
8. Once the water is at the correct level and air is bled, turn on the power at the GFCI breaker.
Note: When the power is turned on, the controls will perform a diagnostic check for a few minutes. When complete, the spa will automatically operate at filter speed and continue heating until water reaches 100°F.
9. If water does not flow from jets when the pump is running, there could be an air pocket. See next page, *Priming the Pump*, for methods of removing air pockets from the pump(s)
10. Install the filter(s) (and weir and basket, if equipped) into the filter chamber.

For Replacement Filters go to:
myworld.ebay.com/strongspas
or call
1-800-STRONG-9

Priming the Pump

Sometimes air can become trapped in the pump while filling the spa. You will know this has happened when after you have filled and started the spa, the pump does not function. You will hear the pump operating, but no water will be moving. **The pump will not work properly while air is trapped in it. Continuing to operate the pump in this way will cause damage.**

New spa owners often have difficulty the first time they start their spa and the pump fails to prime. This can be frustrating, but these simple instructions can help you.

To remove small air bubbles trapped in the pump.

1. Turn the spa on and wait for **PR** (Priming Mode) to appear on the topside display.
2. Press the JETSI button to turn on the pump and let it run for 10 seconds. The pump should be running on low speed.
3. Press the JETSI buttons again and let the pump run on high speed for 10 seconds.
4. Press the JETSI button again to turn off the pump. The pump should be left in the off position for 10 to 15 seconds.
5. Repeat steps 1 through 4 until water is flowing through all the jets and all air is removed from the plumbing.



To remove a large air lock within the pump:

1. Turn off power at the breaker.
2. Remove the spa panel closest to the pump.
3. Loosen the white Pressure Union on top of the pump by hand or with a strap wrench. When air is bled out, tighten the union, turn breaker on and set the pump on high speed.



Note: If you press the Temp button any time during Priming Mode, it will exit that mode and begin Standard Mode.

Operate Your Spa

Topside Control Panels

One-Pump Spas



System Settings

When your spa is first actuated, it will go into Priming mode, indicated by “Pr.” The Priming mode will last for less than 5 minutes (press “Warm” or “Cool” to skip Priming Mode) and then the spa will begin to take temperature readings, followed by the heater test cycle. After completed, the heater will turn on, heat the spa and maintain the water temperature in the Standard mode.

The start-up temperature is set at 100°F/37°C. The last measured temperature is constantly displayed on the LCD. Note that the last measured spa temperature displayed is current only when the pump has been running for at least 2 minutes.

To display the set temperature, press the “Warm” or “Cool” pad once. To change the set temperature, press the pad a second time before the LCD stops flashing. Each press of the “Warm” or “Cool” pad will continue to either raise or lower the set temperature. After 3 seconds, the LCD will stop flashing and display current spa temperature.

Maximum Temperature is set at 104°F/40°C as required by UL/CSA.

Minimum temperature is 80°F/26°C.

Note: If the spa is currently in a heating or filtration cycle the pump will only switch between high and low. It cannot be turned off until the heating or filtration cycle is completed.

Jets

Touch the “Jets” button once to turn the pump on or off, and to shift between low and high speeds. If left running, the low speed of the pump will automatically turn off after 2 hours, and the high speed will automatically turn off after 15 minutes.

Light

Press “Light” button to turn the light on/off. If left on, the light automatically turns off after 4 hours. See page 25 for lighting specifics.

Preset Filter Cycles

The first filter cycle begins 6 minutes after the spa is energized. The second filter cycle begins 12 hours later. Filter duration is programmable for 2-(C)on- tinuous per 12 hours. The default filter time is 2 hours.

Example 1: In a 12 hour period (1 cycle), a setting of F2 means 2 hours of filtration on, 10 hours of filtration off.

Example 2: In a 12 hour period (1 cycle), a setting of F4 means 4 hours of filtration on, 8 hours of filtration off.

You may choose F2, F4, F6, F8 or c (continuous).

To program, press “Warm” then “Jets”. Press “Warm” to adjust. Press “Jets” to exit.

Mode

Mode is changed by pressing the “Warm” or “Cool” button, then pressing the “Light” button. In Economy and Sleep Mode, heating only occurs during the filter cycle. See Mode, page 18.

Freeze Protection

If the temperature sensors detect a drop to below 44°F/6.7°C within the heater, the pumps will automatically activate to provide freeze protection. The equipment stays on until 4 minutes after the sensors detect that the spa temperature has risen to 45°F/7.2°C or higher.

Control Pack Codes See pages 19-21.

One-Pump + Blower Spas or Two-pump (2-speed + 1-speed)



System Settings

When your spa is first actuated, it will go into Priming mode, indicated by “Pr.” The Priming mode will last for less than 5 minutes (press “Temp” to skip Priming Mode) and then the spa will begin to take temperature readings, followed by the heater test cycle. When complete, heater will turn on, heat spa and maintain the temperature in Standard mode.

The start-up temperature is set at 100°F/37°C. The last measured temperature is constantly displayed on the LCD. Note that the last measured spa temperature displayed is current only when the pump has been running for at least 2 minutes.

To display the set temperature, press the “Temp” pad once. To change the set temperature, press the pad a second time before the LCD stops flashing. The temperature will either go up or down. To change the temperature in the opposite direction wait for the LCD to stop flashing, press the “Temp” pad once, then press the “Temp” pad again to reverse the temperature direction. After three seconds, the LCD will stop flashing and display the current spa temperature.

Maximum Temperature is set at 104°F/40°C as required by UL/CSA.

Minimum temperature is 80°F/26°C.

Note: If the spa is currently in a heating or filtration cycle the pump will only switch between high and low. It cannot be turned off until the heating or filtration cycle is completed.

Jets

Touch the “Jets” button once to turn the main 2-speed pump on or off, and to shift between low and high speeds. If left running, the low speed of the pump will automatically turn off after 2 hours, and the high speed will automatically turn off after 15 minutes. The “Boost” button will operate the blower pump, if equipped, or the 1-speed pump.

Light, Preset Filter Cycles, Mode and Freeze Protection

See page 14.

Control Pack Codes

See pages 19-21.

Two-Pump Spas and Two-Pump + Blower Spas



System Settings

When your spa is first actuated, it will go into Priming mode, indicated by “Pr.” The Priming mode will last for less than 5 minutes (press “Warm” or “Cool” to skip Priming Mode) and then the spa will begin to take temperature readings, followed by the heater test cycle. After completed, the heater will turn on, heat the spa and maintain the water temperature in the Standard mode.

The start-up temperature is set at 100°F/37°C. The last measured temperature is constantly displayed on the LCD. Note that the last measured spa temperature displayed is current only when the pump has been running for at least 2 minutes.

To display the set temperature, press the “Warm” or “Cool” pad once. Each press of the “Warm” or “Cool” pad will continue to either raise or lower the set temperature. After three seconds, the LCD will display the current spa temperature.

Maximum Temperature is set at 104°F/40°C as required by UL/CSA.

Minimum temperature is 80°F/26°C.

Jets 1

Touch the “Jets 1” button once to turn pump 1 on or off, and to shift between low and high speeds. If left running, the low speed of the pump will automatically turn off after 2 hours, and the high speed will automatically turn off after 15 minutes.

Jets 2

Touch the “Jets 2” button once to turn pump 2 on or off and to shift between low and high speeds. If left running, pump 2 will automatically turn off after 15 minutes.

Option

This button is used to turn on the blower pump in 3 pump spas (2 water pumps + 1 air pump).

Operate Your Spa

Light, Mode, Preset Filter Cycles and Freeze Protection

See page 14.

Control Pack Codes

See pages 19-21.

Three-Pump Spas and Two-Pump + Blower Spas



Temperature

Temp Set (80°F - 104°F / 26.0°C - 40.0°C)

The last measured temperature is constantly displayed on the LCD. Your spa's set temperature range may vary from range shown above depending on your manufacturer's settings.

Note that the last measured spa temperature displayed is current only when the pump has been running for at least 1 minute.

Maximum Temperature is set at 104°F/40°C as required by UL/CSA.

Minimum temperature is 80°F/26°C.

Cool/Warm

Press the "Cool" or "Warm" button once to display the set temperature. Each time either button is pressed again, the set temperature will increase or decrease depending on which button is pressed. After three seconds, the LCD will automatically display the last measured spa temperature.

Mode

This button is used to switch between Standard, Economy, and Sleep modes. Press "Mode" to enter mode programming, press "Cool" to cycle through to desired mode (LCD flashes until confirmed), then press "Mode" to confirm selection.

Standard mode maintains the desired temperature. Note that the last measured spa temperature

displayed is current only when the pump has been running for at least 1 minute. "Std" will appear on the display momentarily when you switch into Standard Mode.

Economy mode heats the spa to the set temperature only during filter cycles. "Ecn" will appear solid when the temperature is not current and will alternate with the temperature when the temperature is current.

Pressing "Jets 1" while in Economy mode puts the spa in **Standard-In-Economy mode**, ("SE") which operates the same as Standard Mode, then reverts to Economy Mode automatically after 1 hour. During this time, pressing "Cool" or "Warm" followed by "Light" will revert the mode to Economy immediately.

Sleep mode heats the spa to within 20°F (11°C) of the set temperature only during filter cycles. "SLP" will appear on the display until mode is changed.

Standby Mode

Pressing "Cool" or "Warm" followed by "Blower" or "Jets 2" or "Aux" will turn off all spa functions temporarily. This is helpful when changing a filter. Pressing any button exits Standby mode. On some systems the "Jets 1" button will control the pump in Standby Mode ("Drain Mode"). In this case, press any other button to exit. System will revert to previous mode after 1 hour.

Jets 1

Press the "Jets 1" button once to turn pump 1 on or off, and to shift between low and high speeds if equipped. If left running, the pump will turn off after a timeout period. The pump 1 low speed timeout on some systems may be as long as 4 hours.

On non-circ systems, the low speed of pump 1 runs when the blower or any other pump is on. It may also activate for at least 1 minute every 30 minutes to detect the spa temperature (polling) and then to heat to the set temperature if needed, depending upon mode. When the low speed turns on automatically, it cannot be deactivated from the panel; however, the high speed may be started.

Jets 2 (optional on some systems)

Press the "Jets 2" button once to turn pump 2 on or off. If left running, the pump will turn off after a

timeout period.

Jets 3 (optional on some systems)

Press the “Jets 3” button once to turn pump 3 on or off. If left running, the pump will turn off after a timeout period.

Blower

1-speed operation: on/off; If left on, the blower will automatically turn off after a timeout period.

Light

Press the “Light” button to turn the spa light on and off, and to switch between different colors. If any light is left on, it will automatically turn off after a factory-programmed time period.

Preset Filter Cycles

On all systems, the pump and the ozone generator will run during filtration. At the start of each filter cycle, the blower will run briefly to purge the air channels. The other pumps will also run briefly.

Freeze Protection

If the temperature sensors within the heater detect a low enough temperature, then the pump(s) and the blower automatically activate to provide freeze protection. The pump(s) and blower will run either continuously or periodically depending on conditions. In colder climates, an optional additional freeze sensor may be added to protect against freeze conditions that may not be sensed by the standard sensors. Auxiliary freeze sensor protection acts similarly except with the temperature thresholds determined by the switch. See your dealer for details.

Control Pack Codes See pages 19-21.

Operational and Energy Tips

I. Control Valves – air and water controls on the top of spa

a. Average to Cold Climate - When not in the spa, make sure the valves are turned off. All these valves will inject a certain amount of air into the

water which causes a cooling effect. Therefore your spa will have to heat more often and cost more money to operate.

b. Hot Climate – Hot tubs are only designed to heat up and maintain temperature, therefore hot climate can actually make a spa over heat. In these areas, the control valves can be left open all the time to help cool the spa down.

2. Filter Settings – Time and Duration

a. Filter settings – review your owner’s manual for specific details

i. Filter times - if your spa has a clock to set, then you set the filter time by the hour and need to change in your programming menu. If no clock then you simply set your filter time by when the spa is turned on. If you power the spa up at 8:00am, then it will filter at 8:00am and 8:00pm daily until the power is turned off and on again.

1. *Savings* – if your electric provider offers different rate per KWH (peak / off-peak) then you will want your filter time to take place during off-peak time.

2. *Cooling a Spa* – if you are experiencing overheating with your spa, have the spa filter during cooler times of the day, and leave the control valves opened like mentioned prior.

ii. Filter setting F2, F4, F6, F8, and FC = filter constantly

1. The factory setting is F2, which means the spa will filter 2 hours for every 12 hour period. 4 hours total per day. Since we use a large primary pump for your filtration, it moves a lot of water quickly. Therefore we recommend you keep your filtration at no more than F4, anything longer will just waste electricity and in warm climates the spa may overheat.

3. Heating Modes – (Balboa Controllers) Standard, Economy, and Sleep

a. 4 Button Controllers Only - These options are not always unlocked from the factory, and may require a settings change. Attempt to change the mode several times prior and if no results a dip switch will need changed.

b. Standard – St, Std

i. Standard is the default setting, and you are in standard mode if none of the other setting

Operate Your Spa

codes show up

1. Temperature will be at or near desired temperature constantly
2. Pumps turn on at regular intervals to check and maintain temperature
3. Best to use at startup of spa, it will heat until desired temperature is reached
4. Best to use in cold climates
5. Most costly to operate

c. Economy – Ec, Ecn

- i. **Economy** is the power saving alternative for regular heating, you will know that you are in economy by the code displayed. If the pump is running the current temperature and code will alternate on the display.
 1. Spa will only heat during filter period
 2. Temperature will remain close to desired, but it will drop between filter periods
 3. If users can get in a routine, filter period should overlap the usage time by a half hour. This will have spa temperature closest to the desired temperature.
 - a. Example, if using the spa at 8:00 have spa filter from 6:30 – 8:30.
 4. Best used in mild to warm climates
 5. Tests show a 20% reduction in energy consumption when compared to standard mode

d. Sleep – SI, SLP

- i. **Sleep** is considered a vacation heater setting, and will maintain your spa water at the most affordable price
 1. Spa will only heat during your filter period
 2. The water temperature may drop up to 20 degrees below your desired temperature

3. Will work in all climates, and will not allow the spa to freeze
4. Tests show a 50%+ reduction in energy consumption when compared to standard mode

4. Steam Loss / Venting Around Spa Cover

a. It is normal to see an occasional burst of steam from around the cover due to pressure releasing from a high to low area. However heat loss can be greatly impacted by use of the spa

- i. **Control valves** should be turned off when getting out of the spa in a cool climate.
 1. Air injects from the cabinet and enters into the water area. That air not only will cool the cabinet area, but will also greatly increase the pressure under the cover and cause more steam to release.
- ii. **Surfaces are different for all spas**, and covers may provide a better seal is spun differently.
 1. If the folding seam goes over the controller area, often more steam will be able to escape. Try to position the cover so that the fold seam goes over the wider top surface areas on the adjacent sides.

Mode

Standard Mode is programmed to maintain the desired temperature. Note that the last measured spa temperature displayed is current only when the pump has been running for at least 2 minutes. “ST” will be displayed momentarily when you switch into Standard Mode. This is the best mode to use during COLD weather.

Economy Mode heats the spa to the set temperature only during filter cycles or if the temperature falls to 20 degrees below set temperature. “EC” will display solid when temperature is not current, and

will alternate with temperature when temperature is current. This is the best mode to use during WARM weather.

Sleep Mode also heats the spa to the set temperature only during filtration cycles. “SL” will display solid when temperature is not current, and will alternate with temperature when temperature is current, but only within 20 degrees of your set temperature.

Note: in all modes, the spa will turn on 1 minute each hour for a temperature reading.

Control Pack Codes

Message	Meaning / Frequency	Action Required
E r E	Firmware install problem.	Contact your dealer or service organization if message appears on more than one power up.
EFE	Configuration error. Spa cannot start up.	Contact your dealer or service organization.
dr	Possible inadequate water, poor flow, or air bubbles in detected in the heater. Spa is shut down for 15 minutes.	If water level is normal, make sure all pumps have been primed. Press any button to reset. This message will reset within 15 minutes.
dr n	The pump is on during Standby Mode to assist in draining the spa.	Press "Jets 1" to turn off the pump when water has drained (or power off the spa.)
dr y dy	Inadequate water detected in heater. (Displays on third occurrence of "dr" message.) Spa is shut down. [1]	Follow action required for dr message. Spa will not automatically reset. Press any button to reset manually.
Ec Ecn	The spa is operating in Economy Mode.	"Ecn" will appear solid on the display when the temperature is not current. "Ecn" will alternate with the temperature when the temperature is current.
FC	As needed.	Continuous Filtration is on.
	"Ice" - Potential freeze condition detected.	No action required. The pumps and the blower will automatically activate regardless of spa status.
HL HFL	A substantial difference between the temperature sensors was detected. This could indicate a flow problem.	Check water level in spa. Refill if necessary. If the water level is okay, make sure the pumps have been primed. Press any button to reset.
HH	"Overheat" - The spa has shut down. [1] One of the sensors has detected 118°F/47.8°C at the heater.	DO NOT ENTER THE WATER. Remove the spa cover and allow water to cool. Once the heater has cooled, reset by pushing any button.
HDE	A pump appears to have been stuck on the last time spa was powered.	POWER DOWN SPA IMMEDIATELY. DO NOT ENTER THE WATER. Contact your dealer or service organization.
IC ICE	"Ice" - Potential freeze condition detected.	No action required. The pumps and the blower will automatically activate regardless of spa status.
LF	Persistent low flow problems. (Displays on the fifth occurrence of the "Heater Flow Low" message within 24 hours.) Heater is shut down, but other spa functions continue to run normally.	Follow action required for "HFL" or "HL" message. Heating capacity of the spa will not reset automatically; you may press any button to reset.

[1] On some systems even when spa is shut down, some equipment may occasionally turn on to continue monitoring temperature or if freeze protection is needed.

[2] Please see the User Manual of the specific panel that the Reminders need to be suppressed.

[3] This is a Reminder Message.

Note: All Messages may not appear on your panel.

Operate Your Spa

OH OHS	"Overheat" - The spa has shut down. [1] One of the sensors has detected that the spa water is 110°F/43.5°C.	DO NOT ENTER THE WATER. Remove the spa cover and allow water to cool. At 107°F/41.7°C, the spa should automatically reset. If spa does not reset, test sensors.
OHH	"Overheat" - The spa has shut down. On some systems, an alarm may sound. One of the sensors has detected 118°F (approx. 47.8°C) at the heater.	DO NOT ENTER THE WATER. Remove the spa cover and allow water to cool. Once the heater has cooled, reset by pushing any button. Test sensors.
Pr	When your spa is first actuated, it will go into Priming mode.	The Priming mode will last for up to 4 minutes and then the spa will begin to heat and maintain the water temperature in the Standard mode.
PSE	Hardware failure.	Contact your dealer or service organization if message appears on more than one power up.
rEC	Hardware failure.	Contact your dealer or service organization.
SA	Spa is shut down. [1] The sensor that is plugged into the Sensor "A" jack is not working.	(May appear temporarily in an overheat condition.)
Sb	Spa is shut down. [1] The sensor that is plugged into the Sensor "B" jack is not working.	(May appear temporarily in an overheat condition.)
SbY	Standby Mode has been activated by pressing a button combination on the user panel.	Press any button, except "Jets 1", to leave Standby Mode and return to normal operation.
SE	The spa is operating in Standard-in-Economy Mode.	Operates the same as Standard mode, then reverts to Economy mode after 1 hour. Press "Mode" to switch directly to Economy mode.

[1] On some systems even when spa is shut down, some equipment may occasionally turn on to continue monitoring temperature or if freeze protection is needed.

[2] Please see the User Manual of the specific panel that the Reminders need to be suppressed.

[3] This is a Reminder Message.

Note: All Messages may not appear on your panel.

<i>Sn</i> <i>SnS</i>	Sensors are out of balance. If this is alternating with the temperature, it may just be a temporary condition. If the display shows only this message (periodically blinking), the spa is shut down. [1]	Test sensor, and replace if bad.
<i>SLP</i>	Sleep Mode has been activated by pressing a button combination on the user panel.	"SLP" will appear solid on the display when the temperature is not current. "SLP" will alternate with the temperature when the temperature is current.
<i>SnA</i>	Spa is shut down. The sensor that is plugged into the Sensor "A" jack is not working.	Test sensor, and replace if bad.
<i>SnB</i>	Spa is shut down. The sensor that is plugged into the Sensor "B" jack is not working.	Test sensor, and replace if bad.
<i>Std</i>	The spa is operating in Standard Mode.	Temperature display is current after pump has been running for at least 2 minutes.
<i>StU</i>	A pump appears to be stuck on, causing the water temperature to creep up, possibly to hazardous levels.	POWER DOWN SPA IMMEDIATELY. DO NOT ENTER THE WATER.

Periodic Reminder Messages (Press the "Mode" button to reset a displayed reminder.)*

Message **	Frequency ***	Action Required
<i>rPH</i>	Every 7 days	Test and adjust pH chemical levels per manufacturer's instructions.
<i>rSA</i>	Every 7 days	Test and adjust sanitizer chemical levels per manufacturer's instructions.
<i>rCL</i>	Every 30 days	Remove, clean, and reinstall filter per manufacturer's instructions.
<i>rG</i>	Every 30 days	Test & reset GFCI per manufacturer's instructions.
<i>rdr</i>	Every 90 days	Drain and refill spa per manufacturer's instructions.
<i>rCO</i>	Every 180 days	Clean and condition cover per manufacturer's instructions.
<i>rtr</i>	Every 180 days	Clean and condition wood per manufacturer's instructions.
<i>rCH</i>	Every 365 days	Install new filter.
<i>rCA</i>	As needed	Install new Mineral cartridge.

* User can suppress all reminders in User Preferences.

[1] On some systems even when spa is shut down, some equipment may occasionally turn on to continue monitoring temperature or if freeze protection is needed.

[2] Please see the User Manual of the specific panel that the Reminders need to be suppressed.

[3] This is a Reminder Message.

Note: All Messages may not appear on your panel.

Operate Your Spa

Pack Reset Instructions VS and GS Models

Tools: Phillips head screwdriver, Needle nose pliers (optional)

First, turn the power off to the spa by using the breaker disconnect. Then, remove the cover to the pack (electrical control unit inside spa). Locate the board diagram on the inside of the cover, and find J43 Persistent Memory. This is located approximately $\frac{3}{4}$ " above and $\frac{1}{2}$ " to the right the red dipswitch bank. It is a small black piece of plastic located between two yellow pieces connected to the board. The jumper on J43 should be hanging on one (1) pin and in a vertical position. Using needle nose pliers (or fingers) gently grab the black jumper and remove from the board. Next, put the jumper back on the pin it came off of in the horizontal position using it to connect the adjacent pin. Proceed to turn the power back on to the spa. Once you see "PR" on the top display, wait one (1) minute and turn the breaker back off. Now reverse the process. Take the black jumper off of both pins and reposition vertically on just one pin (this is done just as a place-saver so the jumper does not become lost). Replace the cover to the pack, and power the spa back on.

Pack Reset Instructions STREL Model

Tool: Phillips head screwdriver

First, turn the power off to the spa by using the breaker disconnect. Then, remove the cover to the pack (electrical control unit inside spa). Once the cover is removed, locate the board diagram on the inside of the cover, and find the red dip switch bank. Using your screwdriver (or fingers) gently switch #12 (the one farthest from you) to the ON position (to the left). Proceed to turn the power back on to the spa. Once the display returns, wait one (1) minute and turn the breaker back off. Now reverse the process, move dip switch #12 back to the off position (to the right). Replace the cover to the pack, and power the spa back on.



Personalized Settings

Jets



Most jets in your spa are adjustable. Rotating the face of an **adjustable jet** to the left (counter-clockwise) will increase the amount of water flow through the jet. Rotating the face of an adjustable jet to the right (clockwise) will decrease the amount of water flow through the jet.



Neck jets can be turned on and off using the nearby **water on/off knob**.



Blower jets are not adjustable, but can be turned on and off using the **Aux** or **Option** button on your Control Panel.

Air Controls



Air controls are the **2" knobs** located around the top of your spa. Each one will let you add a mixture of air with the jet pressure. This is accomplished by rotating the air control knob to the left (counterclockwise) to increase the amount of airflow through the jets. To decrease the amount of airflow through the jets, rotate the handle to the right (clockwise).

Diverter Knobs (if equipped)



Diverter knobs are **3" knobs** located around the top of your spa. They allow you to divert water through jets from one side of the spa to the other, or in most cases from floor jets to wall jets. This is accomplished by rotating the diverter knob to the left (counterclockwise), decreasing the amount of water flow through a section of jets. To increase the amount of water flow through the other section of jets, rotate the handle to the right (clockwise).

Remotes (if equipped)



Remote Controls operate like the **Jets** button on your control panel. For dual-speed pumps, press the center of the remote once to turn pump on low, again to turn pump on high, and a third time to turn the pump off. One remote control operates Pump 1, the other operates Pump 2.

On models equipped with one-speed secondary and tertiary pumps, press the center button once to turn pump on and once to turn off. One remote control operates Pump 2, the other operates Pump 3.

Waterfall Controls (if equipped)



Some spas include waterfalls. Increase or decrease the flow of the waterfall using the **2" water on/off knob** nearest the waterfall.

Pop-up Water Columns *(if equipped)*



IMPORTANT!

When spa session is over, and before cover is closed, **these pop-up water features MUST be turned off using the water control knob nearest the feature.** Pushing

them down by hand or with the weight of the cover will not turn them off, and water will continue to run through them, potentially causing draining of your spa, depending on how long they are left on.

Lighting

Underwater Light, LED Points of Light on Spa Shell and/or Spa Perimeter *(if equipped)*



Press the **Light** button on the topside control panel to turn the spa light on. If your spa has perimeter LED lights, they will also light up at the same time as the spa light.

Perimeter lights operate in four modes. The mode is changed by turning the light off and then immediately back on

1. Fading: The first time you press the **Light** button, the lights will cycle through all the colors in this order: White, Cyan, Magenta, Blue, Yellow/Green, Green, Red

2. Color Locked: This cycle offers a hard color change without fading.

3. Quick Color Change: To cycle through the different color choices, press the **Light** button repeatedly. Each time you press the button, you advance to the next color.

4. Flashing white: When you have cycled through all the colors, the next time you push the **Light** button, the LED lights will flash white.

Testing and Adjusting Water

As the owner of a Strong Spa, it is important that you maintain your spa water and keep your spa equipment in excellent condition. To do so, you must first balance your spa water. If your spa is equipped with an ozone generator it will automatically produce ozone, but it cannot be used as the sole means of maintaining safe spa water. You must select and use a spa chemical system in addition to your ozone generator. The ozone generator is a wearable, non-warranty item and it needs to be replaced approximately every two years.

Routine Water Maintenance

Good spa water requires regular maintenance. Establish a routine based on a regular schedule for your spa water maintenance. Maintaining your water quality helps the enjoyment of your spa and extends your spa's life. See page 30.

Sanitation

You will need to decide which chemical sanitizer you wish to use, regardless of the presence of an ozonator. Spa owners with an ozonator still need to use a chemical sanitizer. Sanitizers kill bacteria and viruses and keep the water clean. A low sanitizer level will allow microbes to grow quickly in the spa water. Use either bromine or chlorine as your sanitizer or a non-chlorine/non-bromine sanitizer. All work well when maintained regularly. Consult your Strong Spas dealer for the right decision with regards to your lifestyle and spa usage.

This manual will cover general chlorine sanitation only. See page 27.



Strong™ Spas does hereby claim no responsibility or liability for use of and quantities of the chemicals used. Read and follow all label instructions.

Do not use third-party salt-based systems in your spa! Damage caused by salt-based systems that have not been factory installed will not be covered under your warranty.

Ozone

Ozone is a natural purifier. Chemically known as O₃, it is produced from simple oxygen molecules in our atmosphere. Ozone is produced in nature from lightning during electrical storms and from ultraviolet rays from the sun. It forms our protective ozone layer. Your spa's ozone generator is designed to duplicate this natural sanitizer. Ozone breaks down and oxidizes oils, suntan lotions, sweat, urea, etc. from spa water more effectively than commercial oxidizers. Ozone works with chlorine or bromine systems in your spa to destroy bacteria and viruses and will do so more effectively. Ozone only leaves simple oxygen in the water as a by-product.

Filtration

Cleaning your filter regularly is the easiest and most effective single thing you can do to keep your water clear. A clogged or dirty filter will cause the heater and pump to work harder than they need to, possibly causing them to fail. The spa's heating system will only function with the proper amount of water flow through the system. See page 29.

The filtering cycle of your spa should be operated at least two hours or more a day (whether or not the heater is heating) to remove impurities and to prevent disposition of contaminants in your spa. The filtering system works automatically. Keep the spa covered when not in use to reduce the loss of heat and to keep debris from settling in the water. See pages 15-19.

Chemical Balance

You will need to test and adjust the chemical balance of your spa water. Although this is not difficult, it needs to be done regularly. Depending on your choice of sanitizer, you need to test the level of calcium hardness, total alkalinity, and pH. See pages 27-29.

Testing Methods

There are 2 types of testing methods:

- The reagent test kit is a method which provides a high level of accuracy. It is available in either liquid or tablet form.
- Test strips are a convenient testing method commonly used by spa owners.

Maintaining Spa Water Quality

Balancing the Total Alkalinity

Total alkalinity (TA) is the measure of the total levels of carbonates, bicarbonates, hydroxides, and other alkaline substances in the water. TA can be considered a pH buffer. It is the measure of the ability of the water to resist changes in pH level.

The recommended total alkalinity is 80 - 120 ppm.

If the TA is too low, the pH level will fluctuate widely from high to low. Low TA can be corrected by adding **alkalinity increaser**.

If the TA is too high, the pH level will tend to be too high and may be difficult to bring down. High TA can be corrected by adding **pH decreaser**.

When the TA is balanced, it normally remains stable, although adding water with high or low alkalinity will raise or lower the TA level.

Balancing the Calcium Hardness

Calcium hardness (CH) is a measure of the total amount of dissolved calcium in the water. Calcium helps control the corrosive nature of the spa's water and is why soft water is not recommended. The low calcium content of soft water is very corrosive to the equipment and can cause staining of the spa shell.

The recommended calcium hardness is 150 - 200 ppm.

If the CH is too low, add liquid hardness increaser.

If the CH is too high, dilute the spa water with soft water or, if this is not available, add stain and scale defense.

When the CH is balanced, it normally remains stable, although adding soft water or very hard water will raise or lower the CH level.

Balancing the pH

The pH level is the measure of the balance between acidity and alkalinity.

The recommended pH is 7.2 - 7.6.

Too alkaline, causes scaling	8.2	↓ Decrease the pH level.
	8.0	
	7.8	
Ideal balance	7.6	
	7.4	
	7.2	
Too acidic, causes corrosion.	7.0	↑ Increase the pH level.
	6.8	
	6.6	

If the pH is too low, it can cause corrosion of metal fixtures and the heating element. See chart to balance.

If the pH is too high, it can cause scaling by allowing metals or minerals to form deposits and stain spa surfaces. See chart to balance.

If Using Chlorine as a Sanitizer

- If you choose to use chlorine as a sanitizer, only use granulated chlorine, not liquid chlorine.
- Once a week, check the chlorine level using either a test strip or a reagent kit. See table for the ideal range.
- Add one or two tablespoons of chlorinating granules to the spa water weekly. Note that chlorine dissipation rate will be faster at higher water temperatures and slower at lower temperatures.
- When you add chlorine, make sure no bathers are in the spa, open all jets and run the spa at high speed with the cover open for at least 30 minutes.
- Follow the maintenance schedule on page 30.

If Using Bromine as a Sanitizer

Bromine is a very effective sanitizer that produces low chemical odors. Unlike chlorine, it can break down bacteria and other impurities to a safe level with a low burn-out rate. The bromine generator requires different water chemistry tests from chlorine systems.

Shocking the Water

In addition to using a chemical sanitizer, you will periodically need to shock the water. Shocking the water helps remove burned-out chemicals, bacteria,

Maintaining Spa Water Quality

Test for:	Ideal Range Min. < > Max.	Chemicals to Use	
		To Raise	To Lower
Total Alkalinity	80 ppm < > 120 ppm	alkalinity increaser	pH decreaser
Calcium Hardness	150 ppm < > 200 ppm	hardness increaser (liquid or powder)	stain scale inhibitor
pH	7.2 < > 7.6	pH increaser	pH decreaser

Test for:	Ideal Range (ppm)		Chemicals to Use To Raise
	Min.	Max.	
Chlorine level without ozonator with ozonator	3.0 2.0	5.0 4.0	chlorinating granules

Chemical Safety

Read and follow all printed instructions listed on bottles and packages. Failure to follow chemical directions may result in serious injury, sickness, or even death.

Add chemicals to the center of the spa with the pump running. Make sure the water is heated. Never add chemicals to cold water, as this will effect chemical action. Also, never add chemicals directly into the skimmer.

 **WARNING!**
Never add chemicals to your spa while bathers are in the spa!

 Do not exceed chemical dosages as recommended on chemical bottles and packages.

 Never change chemical brands or types without completely draining, flushing and thoroughly cleaning the spa and cover first.

 **WARNING!**
Never mix chemicals together.

 Do not allow chemicals to come in contact with skin, eyes or clothing. Remove and wash clothing that may have been exposed to chemical contact prior to wearing them again.

 Inhaling or ingesting chemicals will cause serious injury, sickness, or even death.

 Chemicals must be stored completely out of the reach of children in an area that is well vented, cool, and dry. Failure to provide a proper area for chemical storage may result in serious injury, sickness, fire explosion and even death. Do not store your chemicals inside the equipment area of your spa.

and other organic material from your spa's water and improves your sanitizer's effectiveness.

Do not use chlorinating shock, which will damage your spa's jets and pump seals. Only use **oxidizer shock**. It is an easy way to maintain chemical plans.

For best results use the directions below.

Add one ounce of oxidizer shock:

- Once a week
- After heavy bather loads
- If water has a strong odor

Spa must be running with all of the jets on high for 30 minutes with the cover open. If necessary, repeat oxidizer shock in 30 minute intervals.

Filter Cleaning

The filter is the part of your spa that removes the debris from the water and needs to be cleaned on a regular basis to maximize your spa's filtering performance and heating efficiency.

In addition to spraying off the filter weekly to remove surface debris, your filter should be deep cleaned periodically to dissolve scale and particles that get lodged deep within the filter fibers and impede the filtration process. Even if the filter looks clean, scale and particles can clog the fibers and prevent water from flowing through the filter resulting in the most common spa problem – no heat, caused by a dirty filter.

We recommend you clean your filter once a month and replace it once every 6 months or as necessary.

1. Remove the filter by turning it counterclockwise, unscrewing the bottom threads, then pulling it up and out.
2. Place the dirty filter into a bucket of water deep enough to cover the filter. Add 8 oz of liquid filter cleaner to the bucket of water.
3. Soak the filter for a minimum of 24 hours.
4. Spray pleats of the filter with a water hose.
5. Reinstall the filter.

Tip: Keep a spare filter to use in the spa while the dirty filter is being deep cleaned.

Starting with Fresh Water

Consult dosage recommendations on the containers that your chemicals are packaged in since they may have similar names and/or usage descriptions but due to manufacturing differences, there is the likelihood of under- or over-dosing the spa chemicals. Damage to the spa or spa components from improper chemical usage is not covered under the spa's warranty. **Important: Make sure the water is heated. Never add chemicals to cold water, as this will effect chemical action. Add chemicals to the center of the spa with the pump running.**

Prior to filling a spa for the first time, or after a routine draining, follow this start-up procedure. Adjust the chemical dosages to the capacity of your particular spa, following label recommendations.

1. Clean the surface of the spa with non-abrasive cleaner.
2. Fill the spa to the proper water level with normal tap water. (Do not use soft water.) Heat your spa to at least 90°.
3. Use test strip and balance the spa water.
 - Adjust total alkalinity (acceptable range is 80-120ppm).
 - Adjust pH if necessary (between 7.2 to 7.8).
4. Add stain and scale prevention.
5. Add two tablespoons of chorine granules to the spa water.
6. Turn on jets for 15 minutes. Leave spa uncovered during this time.
7. Put cover on spa and allow to heat up to desired temperature.

Water level is very important. If the water level is too low or too high, your spa will not operate properly. The water level should be about two inches over the highest jet (excluding neck/shoulder jets) when the spa is not being used.

Maintenance Schedule

Each time you refill the spa

- Follow the section *Starting with Fresh Water*.

Prior to each use

- Test the spa water using either test strips a reagent test kit.
Adjust chemical levels as necessary.

Once a week

- Test the spa water using either test strips a reagent test kit.
Adjust chemical levels as necessary.

Once a month

- Deep clean your spa's filter. See page 29.
- Apply spa vinyl cleaner/protectant to vinyl spa soft cover and pillows.

Every two to three months

- Drain and clean your spa with non-abrasive cleaner.
- Polish shell with acrylic surface cleaner.
- Refill your spa, following the section *Starting with Fresh Water*.

Every four to six months

- Change your spa water. You may find the need to change your spa water more frequently with heavy use. When empty, your spa should be cleaned with a non-abrasive cleaner and then rinsed thoroughly.

Once a year

- Replace filter cartridges if the pleats appear frayed.

Every 2 years

- Replace your ozonator.

Troubleshooting Water Quality Problems

Problem	Probable Causes	Possible Solutions
Water is cloudy	<ul style="list-style-type: none"> • Dirty filter • Inadequate or improper sanitizing • Oils, lotions, organic matter • Old water 	<ul style="list-style-type: none"> • Clean the filter • Run jet pumps and clean filter • Add sanitizer • Shock spa with sanitizer • Adjust pH or alkalinity to balance • Drain and refill spa
Algae	<ul style="list-style-type: none"> • pH too high • Sanitizer too low 	<ul style="list-style-type: none"> • Shock spa with Sanitizer. Adjust pH • Shock spa with sanitizer and maintain good sanitizer level
Organic buildup or scum ring around spa	<ul style="list-style-type: none"> • Oils, dirt in spa water 	<ul style="list-style-type: none"> • Wipe off scum ring using a clean rag. In extreme cases, you may need to drain, clean and refill your spa.
Water odor	<ul style="list-style-type: none"> • Organics • Inadequate or improper sanitizing • pH too low 	<ul style="list-style-type: none"> • Shock spa with sanitizer • Add sanitizer • Adjust pH to balance
Chlorine odor	<ul style="list-style-type: none"> • Chloramine level too high • pH too low 	<ul style="list-style-type: none"> • Shock spa with sanitizer • Adjust pH to balance
Musty odor	<ul style="list-style-type: none"> • Algae or bacteria 	<ul style="list-style-type: none"> • Shock spa with sanitizer. If problematic or visible, you may need to drain, clean and refill your spa.
Eye irritation	<ul style="list-style-type: none"> • pH too low • Sanitizer too low 	<ul style="list-style-type: none"> • Adjust pH to balance • Shock spa with sanitizer and maintain good sanitizer level
Skin irritation or rash	<ul style="list-style-type: none"> • Unsanitary water quality • Free chlorine level too high (above 5 ppm) 	<ul style="list-style-type: none"> • Shock spa with sanitizer and maintain good sanitizer level • Allow level to drop naturally to below 5 ppm before using spa
Stains	<ul style="list-style-type: none"> • Total alkalinity and/or pH are too low • High amounts of copper or iron in water 	<ul style="list-style-type: none"> • Adjust total alkalinity and/or pH • Use stain and scale inhibitor
Scale	<ul style="list-style-type: none"> • Calcium content of water is too high. Total alkalinity and pH are too high. 	<ul style="list-style-type: none"> • Adjust total alkalinity and pH. If needed, drain spa, scrub off scale, then refill and balance water. • Use stain and scale inhibitor

Troubleshooting Operations

Symptom	Possible Cause(s)	Possible Solution(s)
POWER		
System does not work	Power is turned off	Reset spa
Control pad and spa equipment do not operate	No electrical power to spa	Turn on or reset the GFCI circuit breaker. If this does not solve the problem, have a qualified electrician check the electrical service.
	The 30A fuse has blown	Contact customer service
The spa does not turn off	Spa is trying to heat up	Check the temperature setting is in Standard mode
	Spa is in filter cycle	Normal. No adjustment necessary
	Spa is in Standard mode	Check setting
Control panel displays a message	An error may have occurred	See diagnostic messages on pages 20-23 for message code meanings
GFCI breaker trips repeatedly	Improper wiring to spa or GFCI breaker is defective	Consult with a qualified electrician
	There is a defective component on spa	Contact customer service
HEAT		
Spa does not heat	Check mode. Set to Standard or Ready	See control panel instructions on pages 20-23.
	Water level is too low	Add water to correct level
	No electrical power to spa	Turn on or reset the GFCI circuit breaker. If this does not solve the problem, have a qualified electrician check the electrical service.
	Heater is defective	Contact customer service
	Gate valve is partially or fully closed	Open gate valves. Note: Never operate your spa with the gate valves closed!
Spa gets warm but not hot	Thermostat has been turned down	Set control panel to higher temperature
	Insufficient filtration time if Sleep or Economy mode	Increase filtration time
	Water level is too low	Add water to correct level
	No electrical power to spa	Turn on or reset the GFCI circuit breaker. If this does not solve problem, have a qualified electrician check the electrical service.
	Dirty filter cartridge	Clean filter cartridge
	Gate valves closed	Open gate valves
	Spa cover improperly positioned	Align spa cover
Spa gets too hot	Filtration time is set too long	Reduce filtration cycles, especially during summer months

Troubleshooting Operations

Symptom	Possible Cause(s)	Possible Solution(s)
WATER		
<i>Water is not clean</i>	For all water clarity problems, see page 31.	
<i>High water consumption</i>	Very high evaporation due to air valves being open	Shut off air valves and refill as necessary
<i>Low water stream from the jets</i>	Running in FILTER mode - slow speed	Select high speed jets
	Blocked wall suctions or skimmer	Clean wall suction/skimmer.
	Dirty filter	Clean filter and replace
	Jets are closed	Open jets
	Gate valves closed	Open gate valves
<i>No water stream from the jets</i>	Pump has airlock	Remove airlock by priming spa (page 13)
	Jets are closed	Open jets
	Power switched off, system off	Reset power
	Pump is defective	Contact customer service
	Pump fluctuations	Low water. Check level on skimmer flap
<i>Water leakage from below spa</i>	Check the connections and drain hoses	Tighten loose connections.
WATER PRESSURE		
<i>Jets surge on and off</i>	Water level is too low	Add water to normal level
<i>Jets are weaker than normal or do not work at all</i>	Jet valves are partially or fully closed	Open jet valves
	Filter cartridge is dirty	See Cleaning the Filter
	Air is trapped in the pump	Remove airlock by priming spa (page 13)
	The suction fittings are blocked	Remove any debris that may be blocking the suction fittings
	Gate valve is closed	Open gate valves. Note: Never operate spa with the gate valves closed!
AIR AND JETS		
<i>No airstream from the jets</i>	Air control not open	Open the control
	Jet spout opening not fixed properly	Check jet spout openings
	Jet spout opening missing	Check jets and replace as necessary
LIGHT(S)		
<i>Standard spa light doesn't work</i>	Light bulb has burned out	Replace light bulb
	Lighting system is defective	Contact customer service

Troubleshooting Operations

Symptom	Possible Cause(s)	Possible Solution(s)
PUMP(S)		
<i>Pump runs constantly – will not shut off</i>	Problem with circuit board	Contact customer service
<i>Noisy pump</i>	Water level is too low	Add water to normal level
	Blocked wall suction or skimmer	Clean the wall suction/skimmer
	Damaged or worn-out motor block	Contact customer service
	Clogged floor suction or skimmer	Clean floor suction or skimmer
	Leakage of air into suction line	Contact customer service
	Debris is inside pump	Contact customer service
	Gate valves are closed	Open gate valves. Note: Never operate your spa with the gate valves closed!
	Damaged or worn motor bearings	Contact customer service
	Improper or defective wiring	Contact customer service
<i>Pump turns off during operation</i>	Automatic timer has completed its cycle	Start the cycle again
	The pump motor is defective	Contact customer service
<i>Pump has a burning smell while running</i>	Damaged or worn motor bearings	Contact customer service
<i>Pump does not work</i>	Power may be turned off	Reset power
	Pump has overheated	Let cool for one hour
	Incorrect or faulty wiring of electrical supply	Contact customer service
	Switch is off	Auto reset after the motor has cooled down
	House circuit breaker tripped or in OFF position	Reset circuit breaker Contact customer service
	Motor overload condition	Motor overload will reset automatically. If problem persists, contact customer service
	Damaged electrical cord	Contact customer service
	Pump cord not plugged in	Plug pump cord into appropriate receptacle
	GFCI tripped or in OFF position	Reset GFCI

Draining Your Spa

Your spa should be drained every four to six months, and refilled with fresh tap water. The following is the recommended method for draining your spa.

1. Turn off the power at the breaker.
2. Remove all filters.
3. Your drain valve is located inside the spa cabinet.
4. Locate hose ending with the 3/4 inch hose shut-off valve.
5. Hook up the female end of a garden hose to the drain fitting.
6. Place the other end of the garden hose where you would like the water to drain to.
7. Twist the hose shut-off valve counterclockwise to open the drain.
8. Let spa drain completely, then remove garden hose.
9. Twist the hose shut-off valve clockwise to close it and replace cap.



Water drained from your spa is safe to dispose of in your yard, septic system or in a drain. Follow all local/municipal codes and regulations for disposal.

Vacation Care

You can leave your spa unattended for up to two weeks if you follow these instructions.

- ALWAYS lock your cover using the cover locks if you plan to be away from home and the spa is filled with water.
- Set the spa to Sleep Mode. (See instructions on page 15-19 for changing modes.)
- Following the water quality instructions starting on page 26, adjust the pH.
- Shock the water (add either chlorine or bromine sanitizer).
- When you return, check and adjust the pH and shock the water.

If you will not be using your spa for longer than 14 days and a spa maintenance service is not available, we strongly recommend you drain or winterize your spa. See page 38 for Winterization Procedure.

Cleaning and Care

Cleaning Your Spa

Spa Shell

Each time you drain your spa, before you refill it you should clean your spa shell with a low detergent, non-abrasive cleaner specifically formulated to clean the spa without damaging its acrylic finish.

1. Spray cleaner directly to the spa's finish.
2. Wipe clean with a soft cloth.
3. Repeat on heavily calcified areas.
4. Wipe spa thoroughly with a wet sponge, rinsing often in a bucket of clean water.
5. Allow the spa to dry completely.

IMPORTANT: Do not use any of these products on spas full of water. Only apply to clean, cool, dry surfaces. Incorrect product usage may cause water issues.

Resin Spa Surface

For normal care and cleaning, use a soft cloth or sponge with soap and water. Rinse well and dry with a soft, clean cloth.

- Clean grease, oil, paint and ink stains with isopropyl (rubbing) alcohol. Rinse well and dry with a soft, clean cloth.
- Never use abrasive cleaners.
- Do not allow your surface to come into contact with nail polish, nail polish remover, wintergreen oil (methyl salicylate), dry cleaning solution, lacquer thinners, gasoline, pine oil, etc.
- Avoid placing razorblades or other sharp instruments on this surface as they may scratch it. Small scratches can be removed by buffing lightly with a clean cloth and using either an automotive polishing liquid or a toothpaste containing a fine polishing ingredient. For deeper scratches, sand the surface lightly with 400 grit "wet or dry" paper and buff with fine-grit buffing compound.

Spa Cover and Pillows

Protect spa cover and pillows by applying a spa vinyl cleaner as part of your monthly maintenance plan. It is specifically designed to protect spa covers and pillows from chemical and ultraviolet light damage without leaving an oily residue behind.

Warning: Do not use automotive vinyl protectants on spa covers or pillows. These products are generally oil-based and will cause severe water clarity issues that are difficult to correct.

Important! Keep the spa covered when not in use!

- Covered spas will use less electricity in maintaining your set temperature.
- Covering your spa will protect your spa's finish from the sun's ultraviolet rays.
- You are required to keep the spa covered to maintain warranty coverage.
- Covering your spa helps prevent children from drowning in the spa. See the photo for instructions on mounting the locks and how to lock and unlock the cover.
- In addition, while a soft spa cover is rigid, it is not designed to support any weight. Therefore, as a safety precaution and to preserve the life of your cover, you must not sit, stand, or lie on it, nor should you place objects of any kind on top of it.

Jet Removal and Replacement

1. Rotate the jet face counterclockwise.
2. Continue to rotate the jet as you pull it out of the jet well.

To replace jets, insert the jet in the jet well and push and rotate it clockwise until you feel it snap into position. When the jet face can be rotated freely, it is properly seated.



Removing and Reseating the Pillows

You can remove the pillows for cleaning and maintenance quickly and easily. This method works for all types of pillows.

To attach 'U'-shaped pillows:
Press plugs gently into sockets.



To remove 'U'-shaped pillows:
Pull gently upward on pillow.

To attach rectangular pillows:

1. Hold pillow LOWER than the final pillow position.
2. Drag the pillow UPWARD allowing the BOTTOM of the bracket to enter the slot in the pillow first.
3. As the pillow begins to attach to the bracket, press inward on the center of the pillow with your fingers.
4. The pillow will snap into place.

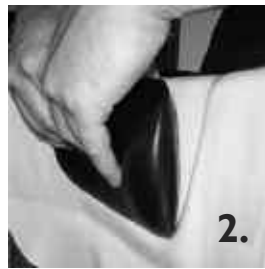

Sound System Feature

(if equipped)

Several options are available and include marine grade CD players and an iPod docking station. Each spa equipped with an audio system is delivered with the manufacturer's operating instructions.

- Make sure that hands and CDs are dry before use.
- Always close the CD protective door.
- Do not place wet CDs into this unit at any time.
- Water damage is not covered by Strong Spas or the manufacturer's warranty.
- The system is water resistant but NOT water-proof. Take every precaution to keep this system dry. Water damage is not covered by Strong Spas or the manufacturer's warranty.

Listening to the Radio

1. Press 'Power' to turn the system on. The system automatically starts in the mode it was in when it was last shut off.
2. Press the MODE button to switch among CD, Aux and Radio modes.
3. Press the UP and DOWN ARROWS located at the far right of the panel to tune the radio to a station.

CD Player:

1. Press the OPEN button on the unit. The faceplate will lower and expose the disk drive.
2. Insert a disk in the disk drive.
3. Flip up the faceplate.
4. To remove the disc, press the OPEN button. The faceplate will open. Press the small EJECT button located below the disk drive slot.

Playing a CD

1. Insert a disc in the disc drive as described above. The player will identify the type of disc and begin playing it.
2. Use either the remote control or the buttons on the faceplate to start and stop the player and to jump to selections.
3. To remove the disc, press the EJECT button.

Winterization Procedure

Important: Damage caused by improper winterization is not covered under the Strong Spas Warranty.

1. Turn off power at the **GFCI** circuit breaker before draining or servicing your spa.
2. Remove exterior panels by inserting a flathead screwdriver at the bottom edge of the panel and prying out (Figure 1).
3. Attach a garden hose to the drain and open the blue ball valve (Figure 2). Water will start to drain. You may have some water left in the spa shell that did not drain. Remove it with a wet-vac or by hand with a small cup.

Water drained from your spa is safe to dispose of in your yard, septic system or in a drain. Follow all local/municipal codes and regulations for disposal.

4. Loosen all large white unions from heater and pump(s) to let excess water drain from the lines (Figure 3). **Your spa may have more than one pump. Be sure to follow winterization procedures for each pump and all unions. A one-pump spa has 4 unions; a two-pump spa has 6.**
5. Remove lowest drain plug on front of each pump (Figure 4). Drain out any water in pump(s).
6. After the spa has drained, you **MUST** also use a wet-vac to remove the water from the lines by vacuum/suction. Water left in the lines and jets will freeze and damage them.

To adequately clean out the lines, place the wet-vac for 10-15 seconds over: each drain (Figure 5); each union (Figures 6 and 7); each jet face (Figure 8); each suction (Figure 9); and the filter cavity (Figure 10). See *filter removal procedure*.

7. After all the water is removed from the spa, jets, and plumbing, re-insert drain plug into each pump (Figure 4). Tighten all unions and make sure all gate valves are open with clips installed (Figure 3).
8. Pour a gallon of spa antifreeze into the top of each pump (Figure 11) and a gallon into the filter cavity (Figure 12).
9. Replace all exterior panels.
10. Close your spa cover.

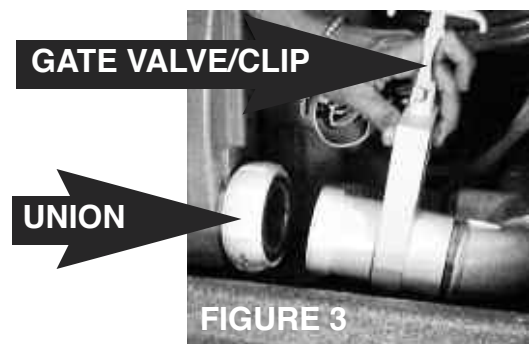

Winterizing and De-Winterizing Your Spa



FIGURE 6



FIGURE 10

Important: Damage caused by improper winterization is not covered under the Strong Spas Warranty.

If you have any questions, please call Strong Spas Technical Support at 1-800-787-6649.

You may also wish to contact a professional to perform these services for you.



FIGURE 7



FIGURE 11

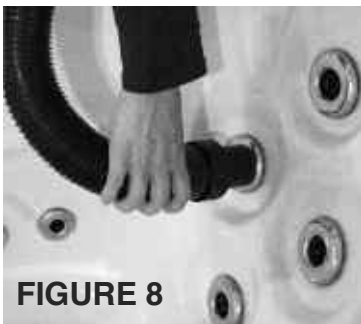

FIGURE 8



FIGURE 12



FIGURE 9

De-Winterization Procedure

1. Fill the spa's footwell with water.
2. Drain the spa to clear the antifreeze out of the spa. See page 35. *Draining Your Spa*, for procedure.

Water drained from your spa is safe to dispose of in your yard, septic system or in a drain. Follow all local/municipal codes and regulations for disposal.

Product Registration

It is important that you register your product as soon as possible.

IMPORTANT: Strong™ Spas Warranty is void if the spa is moved to any location that is not the original 'Ship To' address.

Locating the product serial number

The serial number of your spa is located on a metal plate attached to exterior of the spa. You will need this number to properly register your spa and activate coverage.

Write this information in the space provided below.

FOR YOUR RECORDS:

Spa Model: _____

Spa Serial Number: _____

Date Purchased: _____

Date Installed: _____

Dealer/Vendor Phone Number: _____

Dealer/Vendor Address: _____

PLEASE FILL OUT SECTION BELOW AND RETURN WITHIN 30 DAYS OF DELIVERY

Place in an envelope and mail to:

Strong Pools and Spas, PO Box 108, Northumberland, PA 17857 USA

•
**or REGISTER YOUR SPA ONLINE AT www.strongspas.com
Under the CONTACT tab select REGISTER YOUR SPA.**

Purchaser's Name: _____ Delivery Date _____

Address _____

City _____ State _____ ZIP _____

Telephone _____

Signature _____

Spa Model: _____

Spa Serial Number: _____

Dealer/Vendor Name _____ Dealer/Vendor Phone _____

Dealer/Vendor Address: _____



For customer service, please call
1-800-787-6649 or email us at
support@strong9.com

Strong™ Spas
3204 Point Township Drive,
Northumberland, PA 17857 USA

READ AND FOLLOW ALL INSTRUCTIONS

To reduce the risk of injury, do not permit children to use this product unless they are closely supervised at all times.

SAVE THESE INSTRUCTIONS